

1064nm High Power Free Space Faraday Isolator

Mode: HIO-6-1064-HP-113X54X54-SD

◆ **Specification:**

Parameters	Unit	Values
Center Wavelength(λ C)	nm	1064
Operating Wavelength Range	nm	± 10
Transmission@ λ c	%	≥ 92
M ² Degradation	%	≤ 10
Isolation@ λ c	dB	≥ 30
Clear Aperture	mm	6 Or Specify
Optical Average Power	W	50
Damage Threshold	J/cm ²	5
Operating Temperature	°C	10 to 30
Storage Temperature	°C	-20 to 70

◆ **Package Dimension:**

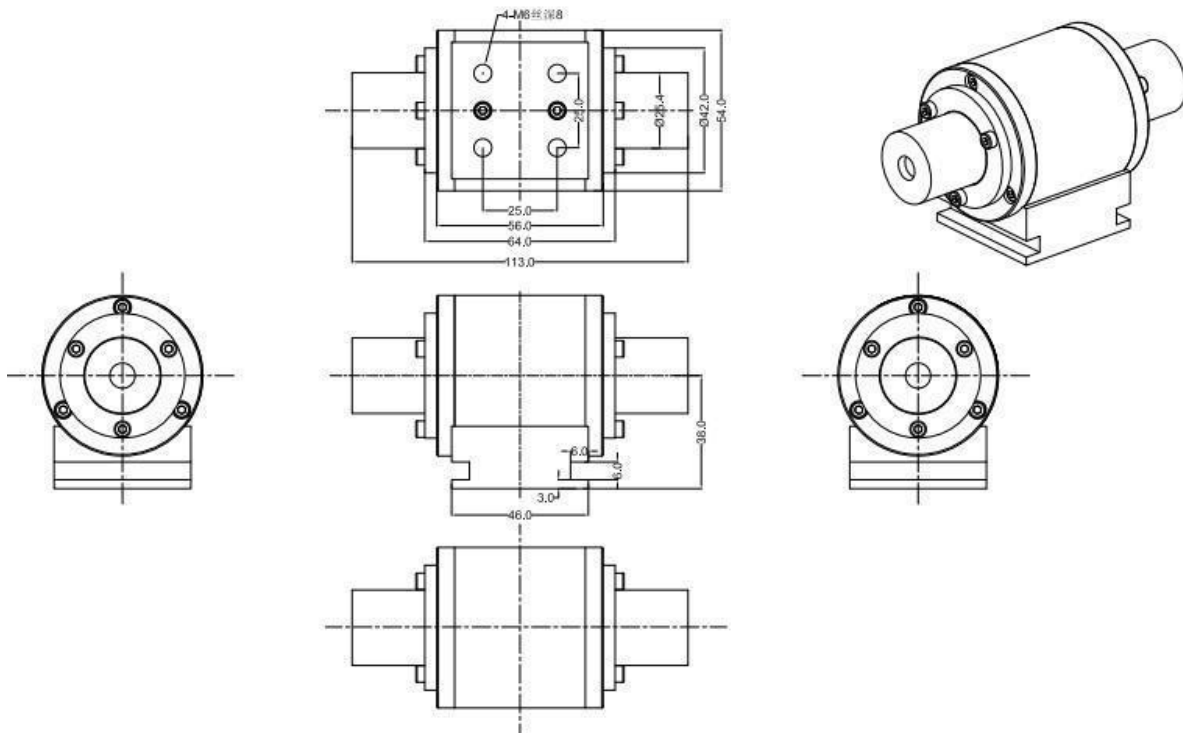

HIO-①-②-③-④

① Clear Aperture	② Center Wavelength	③ Handling Power	④ Package Dimension
2.8-2.8mm	1030-1030nm	HP-High Power	81x52x38
5-5mm	1064-1064nm	LP-Low Power	113x54x54
S-Specify	1550-1550nm		S-Specify